

Power MIG Series



GeKaMac®



Power MIG 500/630 Users Manual

Please Read and Understand This Manual
Before Operating The Welding Machine

www.gedikwelding.com

Dear Customer

This instruction manual will help you get to know your new machine. Read the manual carefully and you will soon be familiar with all the many great features of your new product. Meanwhile, please remember well safety rules and operate as instruction.

If you treat your product carefully, this definitely helps to prolong its enduring quality and reliability—things which are both essential prerequisites for getting outstanding results.

Production specification may change without advance notice.

The model you purchase is:

- PoWer MIG 500**
- PoWer MIG 630**

Please find corresponding models from the "Contents".

Important:

Please take special note of safety rules and operate as instruction in case of damage and serious injury.

Safety Rules



“**Danger**” indicates an imminently hazardous situation which, if not avoided, will result in death or serious injury.



“**Warning!**” indicates a possible hazardous situation which, if not avoided, could result in death or serious injury. The possible hazards are explained in the text.



“**Caution**” indicates a possible hazardous situation which, if not avoided, may result in slight or moderate injury.



“**Note!**” indicates a situation which implies a risk of impaired welding result and damage to the equipment.

“**Important!**” indicates practical tips and other useful special-message. It is no signal word for a harmful or dangerous situation.



Utilization for intended purpose only

- The machine may only be used for jobs as defined by the “Intended purpose”.
- Utilization for any other purpose, or in any other manner, shall be deemed to be “not in accordance with the intended purpose”. The manufacturer shall not be liable for any damage resulting from such improper use.



Safety signs

- All the safety instructions and danger warnings on the machine must be kept in legible condition, not removed, not be covered, pasted or painted cover.



Safety inspection

- The owner/operator is obliged to perform safety inspection at regular intervals.
- The manufacturer also recommends every 3-6 months for regular maintenance of power sources.



Electric shock can kill

- Touching live electrical parts can cause fatal shocks or severe burns. The electrode and work circuit is electrically live whenever the output is on. The input power circuit and machine internal circuits are also live when power is on. In MIG/MAG welding, the wire, drive rollers, wire feed housing and all metal parts touching the welding wire are electrically live. Incorrectly installed or improperly grounded equipment is a hazard.
- Do not touch live electrical parts of the welding circuit, electrodes and wires with your bare skin or wet clothing.
- The operator must wear dry hole-free insulating welding gloves and body protection while performs the welding.
- Insulate yourself from work and ground using dry insulating protection which is large enough to prevent you full area of physical contact with the work or ground.
- Connect the primary input cable according to rules. Disconnect input power or stop machine before installing or maintenance.
- If welding must be performed under electrically hazardous conditions as follow: in damp locations or wearing wet clothing; on metal structures such as floors, gratings, or scaffolds; when in cramped positions such as sitting, kneeling, or lying; or in occasion when there is a high risk of unavoidable or accidental contact with the work piece or ground. Must use additional safety precautions: semiautomatic DC constant voltage (wire) welder, DC manual (Stick) welder and AC welder with reduced open-load voltage.
- Maintain the electrode holder, ground clamp, welding cable and welding machine in good, safe operating condition. Replace damaged part immediately.



Electric and magnetic fields (EMF) may be dangerous

- If electromagnetic interference is found to be occurring, the operator is obliged to examine any possible electromagnetic problems that may occur on equipment as follow:
 - mains, signal and data-transmission leads
 - IT and telecoms equipment
 - measurement and calibration devices
 - Wearers of pacemakers
- Measures for minimizing or preventing EMC problems:
 - Mains supply

If electromagnetic interference still occurs, despite the fact that the mains connection in accordance with the regulations, take additional measures

- Welding cables

Keep these as short as possible

Connect the work cable to the work piece as close as possible to the area being welded.

Lay term well away from other cables.

Do not place your body between your electrode and work cables.

- Equipotential bonding
- Workpiece grounding (earthing)
- Shielding

Shield the entire welding equipment and other equipment nearby.

ARC rays can burn



- Visible and invisible rays can burn eyes and skin.
- Wear an approved welding helmet or suitable clothing made from durable flame-resistant material (leather, heavy cotton, or wool) to protect your eyes and skin from arc rays and sparks when welding or watching.
- Use protective screens or barriers to protect other nearby personnel with suitable, non-flammable screening and/or warn them not to watch the arc nor expose themselves to the arc rays or to hot spatter or material.

Fumes and gases can be dangerous



- Welding may produce fumes and gases, breathing these fumes and gases can be hazardous to your health.
- When welding, keep your head out of the fume. If inside, ventilate the area at the arc to keep fumes and gases away from the breathing zone. If ventilation is not good, wear an approved air-supplied respirator.
- Work in a confined space only if it is well ventilated, or while wearing an air-supplied respirator.
- Welding fumes and gases can displace air and lower the oxygen level causing injury or death. Always use enough ventilation, especially in confined areas, to insure breathing air is safe.

Welding and cutting sparks can cause fire or explosion



- When not welding, make sure the electrode circuit is not touching the work or ground. Accidental contact can cause sparks, explosion, overheating, or fire. Make sure the area is safe before doing any welding.
- Welding and cutting on closed containers, such as tanks, drums, or containers, can cause them to blow up. Make sure proper steps have been taken.
- When pressure gas is used at the work site, special precautions are required to prevent hazardous situations.
- Connect work cable to the work as close to the welding zone as practical to prevent welding current from passing too long and creating fire hazards or overheat.
- Wear oil-free protective garments such as leather gloves, heavy shirt, cuffless trousers, high shoes, and a cap. Wear ear plugs when welding out of position or in confined places. Always wear safety glasses with side shields when in a welding area.
- Be attention that welding sparks and hot materials from welding can easily go through small cracks and openings to adjacent areas and start a fire. Remove fire hazardous from the welding area, if not possible, cover them thoroughly. Do not weld where flying sparks can strike flammable material and where the atmosphere may contain flammable dust, gas, or liquid vapors (such as gasoline).
- Protect yourself and others from flying sparks and hot metal. Remove any combustibles from operator before perform any welding.
- Keep a fire extinguisher readily available.
- Empty containers, tanks, drums, or pipes which have combustibles before perform welding.
- Remove stick electrode from electrode holder or cut off welding wire at contact tip when not in use.
- Apply correct fuses or circuit breakers. Do not oversize or bypass them.

Cylinder can explode if damaged



- Pressure gas cylinders contain gas under high pressure. If damaged, a cylinder can explode. Since gas cylinders are normally part of the welding process, be sure to treat them carefully.
- Cylinders should be located away from areas where they may be struck or subjected to physical damage. Use proper equipment, procedures, and sufficient number of persons to lift and move cylinders.
- Always install cylinders in an upright position by securing to a stationary support or cylinder rack to prevent falling over or tipping.
- Keep a safe distance from arc welding or cutting operations and any other source of heat, sparks, or flame.
- No touching cylinder by welding electrode, electrode holder or any other electrically "hot" parts. Do not drape welding cables or welding torches over a gas cylinder.
- Use only correct compressed gas cylinders, regulators, hoses, and fittings designed for the process used; maintain them and associated parts in good condition.
- Use only compressed gas cylinders containing the correct shielding gas for the and properly operating regulators designed for the gas and pressure used. All hoses, fittings, etc. should be suitable for the application and maintained in good condition.
- Open the cylinder valve slowly and keep your head and face away from the cylinder valve outlet.
- Valve protection caps should be kept in place over valve expect when the cylinder is in use or connected for use.



Hot parts can burn

- Do not touch hot parts with bare hand or skin.
- Ensure equipment is cooled down before perform any work.
- If touching hot parts is needed, use proper tools and/or wear heavy, insulated welding gloves and clothing to prevent burns.



Flying metal or dirt can injure eyes

- When welding, chipping, wire brushing, and grinding can cause sparks and flying metal. It can hurt your eyes.
- Remember wear appropriate safety glasses with side shields when in welding zone, even under your welding helmet.



Noise can damage hearing

- Noise from some processes or equipment can damage hearing.
- Remember wear approved ear protection to protect ears if noise level is high.



Moving parts can injure

- Stay away from moving parts such as fans.
- Stay away from pinch points such as drive rolls.
- Keep all doors, panels, covers, and guards closed and securely in place.
- Have only qualified persons remove doors, panels, covers, or guards for servicing and maintenance.
- Reinstall doors, panels, covers, or guards when servicing and maintenance is finished and before reconnecting input power.



Overuse can cause overheating

- Use machine follow duty cycle. Reduce current or reduce duty cycle before starting to weld again.
- Allow cooling period.
- Do not block or filter airflow to unit.



Static can damage PCB

- Always wear wrist straps before touching PCB or parts.
- Use proper static-proof bags and package to store or move PCB.



Safety markings

- Equipment with CE-markings meets the basic requirements of the Low-Voltage and Electromagnetic Compatibility Guideline (e.g. relevant product standards according to EN 60 974).



Safety markings

- The equipment with the CCC mark meets the basic requirements stipulated in the Chinese standards GB / T15579.1-2013 and GB / T8118.



Safety markings

- This marking means that the product is certified for both the U.S. and Canadian markets, to the applicable U.S. and Canadian standards. The preferred location of the indicators is as shown.

Contents

1- GENERAL REMARKS	6
1-1 Power source features	6
1-2 Functional principle	6
1-3 Output characteristics	6
1-4 Duty cycle	7
1-5 Applications	7
1-6 Warning label	8
2- VERSIONS BRIEFS	8
3- BEFORE COMMISSIONING	9
3-1 Utilization for intended purpose only	9
3-2 Machine installation rules	9
3-3 Power source connection	9
3-4 Welding cables instruction	9
4-PoWer MIG 500/630	11
4-1 System components	11
4-2 Basic equipments for welding	11
4-3 Control panel	11
4-4 Interface	14
4-5 Installation	15
4-6 Welding process	16
4-7 Technical data	16
4-8 Dimension	17
4-9 Disassembly and reassembly	18
5- TROUBLE SHOOTING	21
6-CARE AND MAINTENANCE	22

1- GENERAL REMARKS

This series of power sources apply IGBT soft switch inverter technology. Its internal control system applies signal processor which ensures quick response to any change during the welding process so as to achieve precise control of welding process and ensure optimal welding results.

1-1 Power source features

Highlights as follows:

- Enjoy reasonable static characteristic and sound dynamic characteristic.
- Less spatter due to the advanced waveform control technology .
- Continuous adjustment of welding current and voltage with wide range .
- 2 step / 4step .
- Perfect functions of starting arc and reducing melting ball while stopping arc .
- Stable wire feeding due to the highly stable power supply from wire feeding circuit .
- Light weight, small size, ideal for portable applications .
- Capable of operation with extended 50 meters long welding cable .

1-2 Functional principle

This series of power sources adopt IGBT soft switch inverter technology to improve the dynamic response rate and make the machines with small size and light weight. The control circuit's closed-loop control makes the power source enjoy strong ability against power grid fluctuation and perfect welding performance.

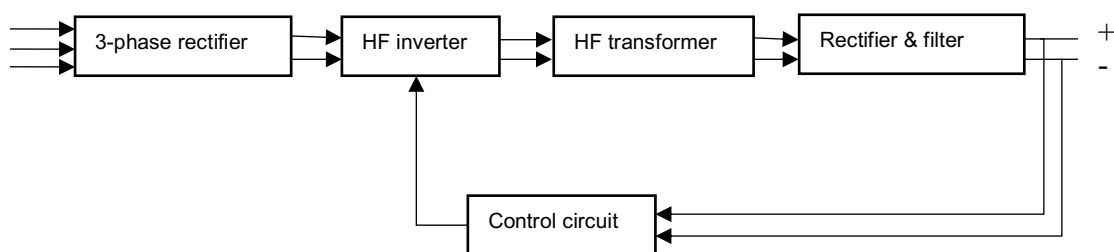

Fig.1-2-1: Schematic diagram

1-3 Output characteristics

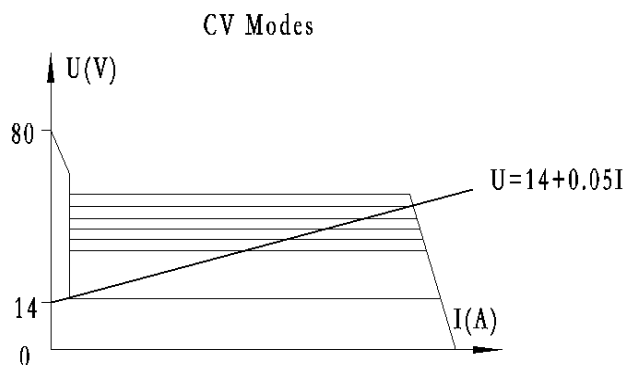

Fig.1-3-1: Output characteristics

1-4 Duty cycle

Duty cycle is percentage of 10 minutes that a machine can weld at rated load without overheating. If overheats, thermostat(s) will open, output stops. Wait for fifteen minutes for the machine to cool down. Reduce amperage or duty cycle before welding.



Note! Exceeding duty cycle can damage the machine and greatly reduce its lifespan.

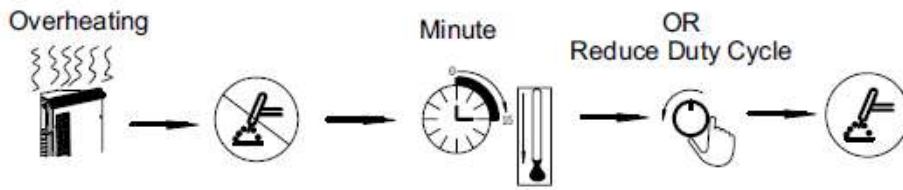
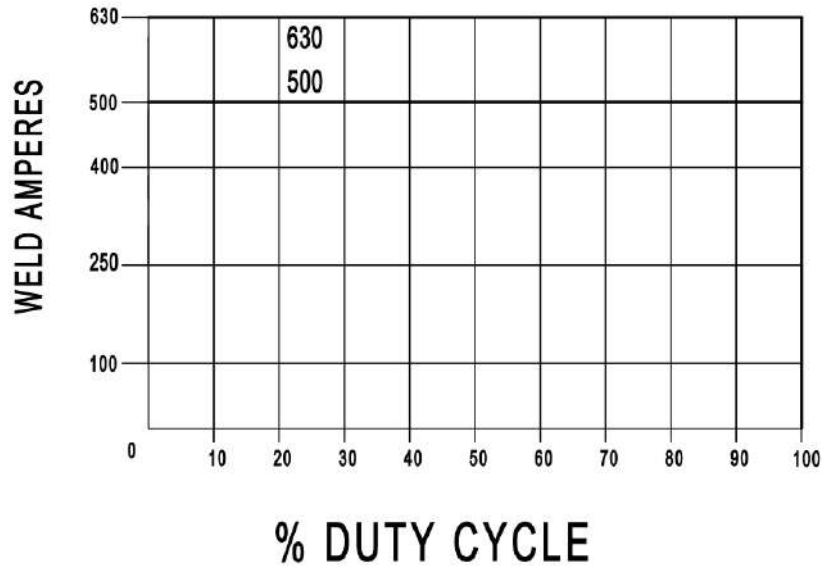

Fig.1-4-1: Duty cycle

1-5 Applications

The MIG power source can be used with solid and flux-cored welding wire for welding carbon steel, alloy steel etc. The power source is designed for the following recommend areas:

- Automobile and car manufacture industry
- Chemical structure and engineering
- Boiler pressure vessel manufacture
- Shipbuilding and offshore engineering
- Vehicle manufacturing
- Mechanical industry
- Other industries

1-6 Warning label

The warning label is affixed on the top of machine.

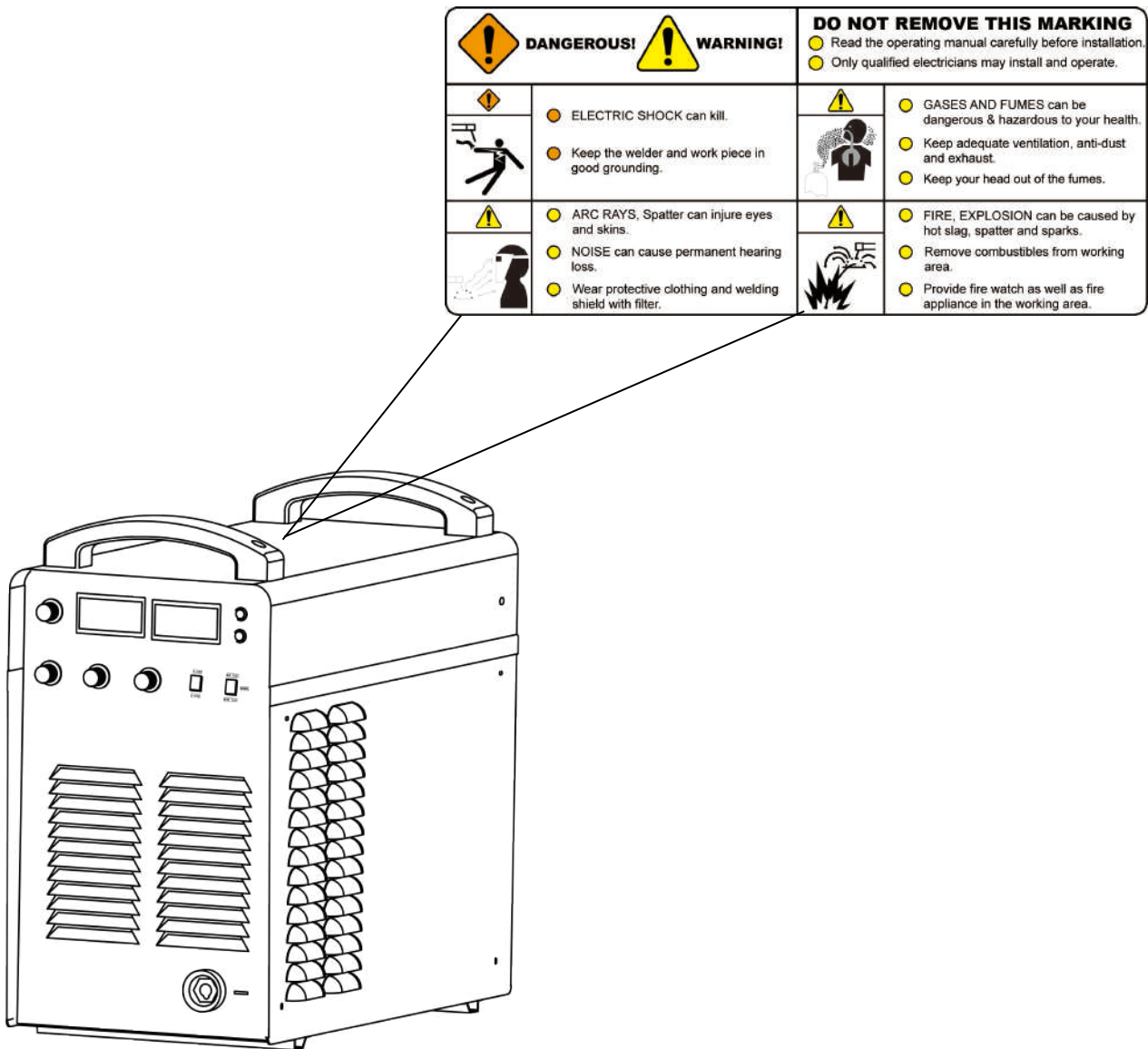

Fig. 1-6-1: Warning label

2- VERSIONS BRIEFS

Professional welding of special materials requires special welding parameters. Different models of the power sources are matched to different welding.

● PoWer MIG 500/630

This series welding machine are designed in accordance with the industrial standard. The welding current and voltage can be adjusted separately. The rated welding current degree is 500A, 630A for this series.

3- BEFORE COMMISSIONING



Warning! Operating the equipment incorrectly can cause serious injury and damage. Do not use the functions described here until you have read and completely understood “safety rules”.

3-1 Utilization for intended purpose only

The power source may only be used for CO2/MAG, Utilization for any other purpose, or in any other manner, shall be deemed to be “not in accordance with the intended purpose”. The manufacturer shall not be liable for any damage resulting from such improper use.

Utilization in accordance with the “intended purpose” also comprises:

- following all the instructions given in this manual
- performing all stipulated inspection and servicing work

3-2 Machine installation rules

According to test, protection degree of this power source is IP21S (optional IP23). However, the internal key components must be protected from direct soaking.



Warning! A machine that topples over or falls from its stand can cause injury. Place equipment on an even, firm floor in such a way that it stands firmly.

The venting duct is very important for safety protections. When choosing the machine location, make sure it is possible for the cooling air to freely enter and exit through the louvers on the front and back of machine. Any electro conductive metallic dust like drillings must not be allowed to get sucked into the machine.

3-3 Power source connection

- The power source is designed to run on the voltage given on the nameplate.
- The mains cables and plugs must be mounted in accordance with the relevant technical standards.
- The power supply sockets that come with power source are designed to use strictly according to the marked voltages.



Note! Inadequately dimensioned electrical installations can lead to serious damage. The mains lead, and its fuse protection, must be dimensioned in accordance with the local power supply. The technical data shown on the nameplate shall apply.

3-4 Welding cables instruction

When welding, please pay attention to the followings:

- a. The welding cables should be kept as short as possible;
- b. If extended cable is used, please do as shown in Fig. 3-4-1.

<p style="text-align: center;">Wrong</p> <p>Coil the excess ground cable and welding cable in same direction respectively.</p>	
<p style="text-align: center;">Correct</p> <p>Straighten the ground cable and welding cable and make them close to each other.</p> <p>Bundle the ground cable and welding cable together, running the wires close to the ground.</p>	
<p style="text-align: center;">Correct</p> <p>When the excess cables are only be used by rolling up, coil the cables to two windings in reverse direction and overlap them.</p> <p>The number of turns for A is same as the number for B.</p> <p>Handle the welding cable and ground cable according to above-mentioned method.</p>	

Fig. 3-4-1: Welding cables instruction

4-PoWer MIG 500/630

4-1 System components

This series of machines can be equipped with many different accessories and can be used in various special sites with different configurations.

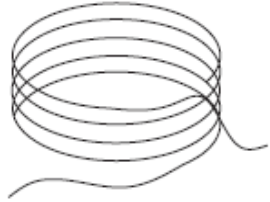
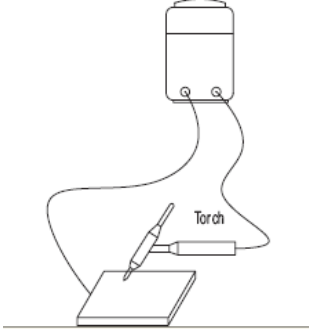
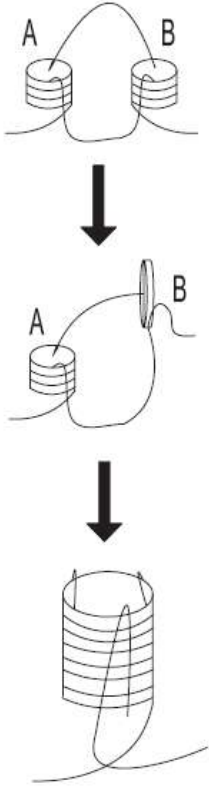
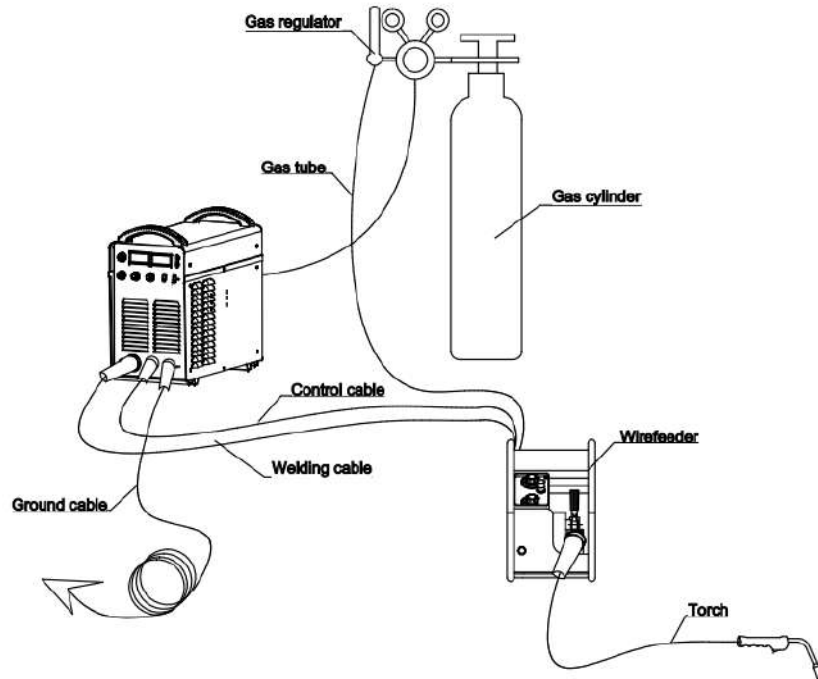

Fig. 4-1-1: System components

4-2 Basic equipments for welding

Only be equipped with the necessary accessories, can the power source operate well. The following is the needed accessories list.

CO₂/MAG welding

- Power source
- Ground cable
- MIG/MAG welding torch
- gas regulator, gas hose, gas cylinder (to supply the machine with shielding gas)
- Wire feeder
- Welding cable
- Control cable
- Welding wire

4-3 Control panel

The control panel is easy to operate. Operators can select various processes by control switch and adjust welding parameters by potentiometer.



Note! Some described parameters in this manual may be slightly different from the power source, some identification may be slightly different from power source identification, but the manner of working is the same.



Warning! Operating the equipment incorrectly can cause serious injury and damage. Do not use the functions described here until you have read and completely understood all content of this manual.

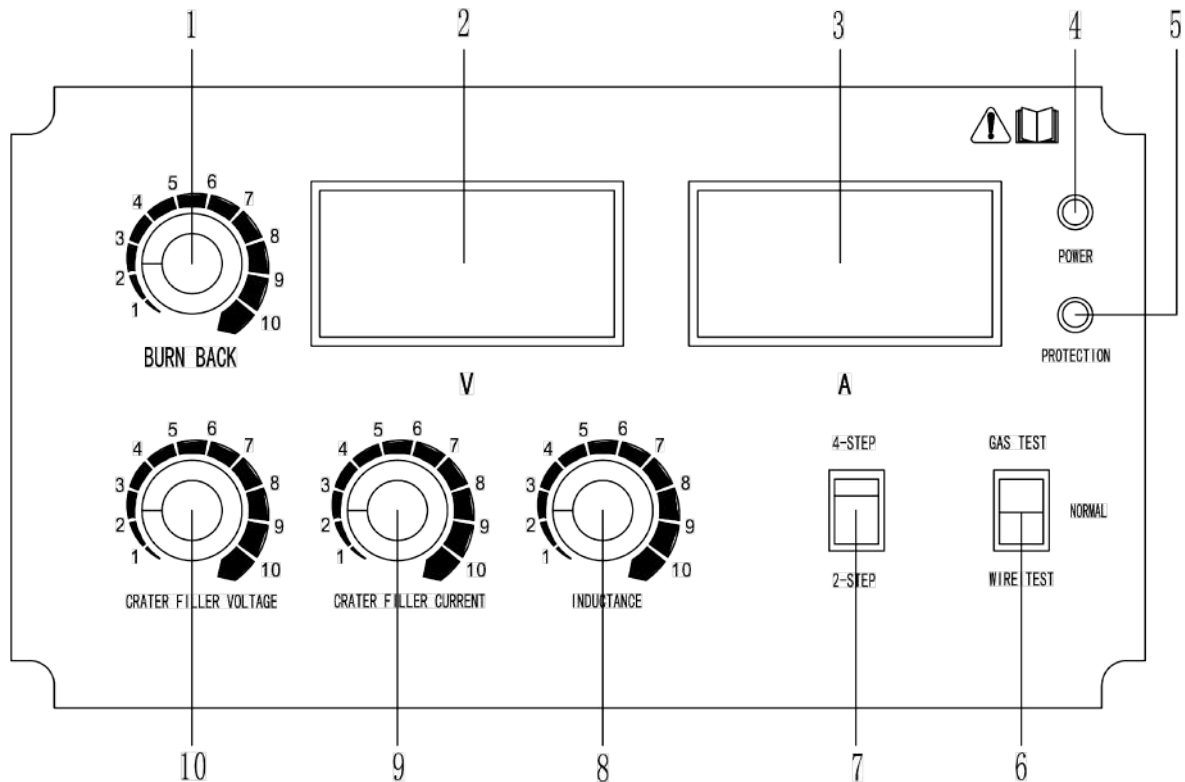

Fig. 4-3-1: Control panel

1. BURN BACK knob

Adjusting the burn-back time can improve the size of the molten ball at the end of the wire; it can prevent the wire sticking to the workpiece.

Note! The design of the welding machine in different periods is different, please refer to the actual product.

2. Voltage display

When in standby, display preset voltage value: 14-50;

When press torch trigger, display open load voltage $70\sim 90V_{dc} \pm 10\%$;

During welding, display actual voltage value;

When disconnected from control cable of wire feeder, displayed value will be higher: 70-90.

3. Current display

When in standby, display preset current value: 3-100; During welding, display actual current value;

When disconnected from control cable of wire feeder, displayed value will be higher: 150-180.

4. Power indicator

Indicate whether the welding machine is power on or not.

5. Protection indicator

During normal welding, the indicator is off;

Indicator lights up and machine will automatically stop working if the power source overheats. Do not cut off the power supply if machine come into overheat protection mode. Keep the fan running until the machine inner temperature recovers to normal and the overheat protection indicator is off, and then start welding after 20 minutes later.

6. Status selection switch

Gas test: when in "GAS TEST" status, the solenoid valve will on, and you can check the gas circuit and alter CO₂ gas flow rate at the pressure regulator;

Wire test: when in "WIRE TEST" status, the function is the same as press the torch switch; you can check the wire feeding and gas feeding; at this time, welding machine outputs open load voltage, arc will start when wire contacts with workpiece;

Normal: can start the normal welding.

7. Torch control switch

Operating mode of torch trigger

Graphic symbol

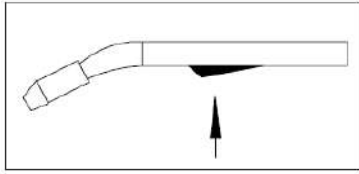

Fig. 4-3-2 Press torch trigger

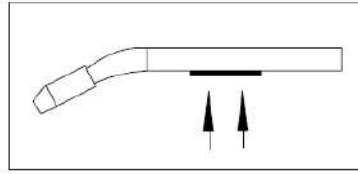

Fig. 4-3-3 Hold torch trigger

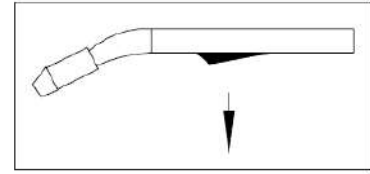

Fig.4-3-4 Release torch trigger

P03.....Pre-gas time

I.....Welding current: Uniform thermal input for the preheated base metals.

P06.....Crater-filler parameter: Prevent burn-through caused by too much heat at the welding ends.

P04.....Post-gas time

P01.....Burn back time

- 2-step mode

It is mainly used for spot welding or short weld seam welding;

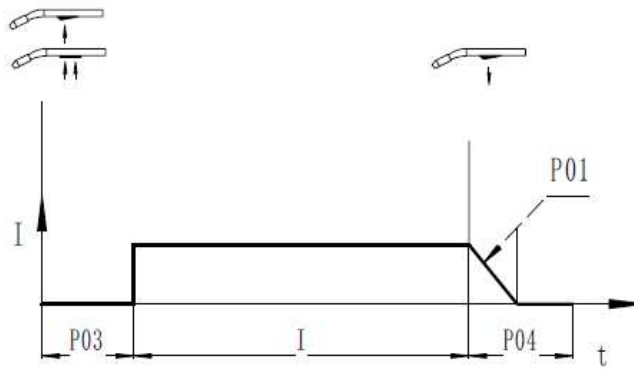

Fig. 4-3-5: 2-step mode

- 4-step mode

This mode is mainly used for long weld seam welding and process that needs crater filler welding.

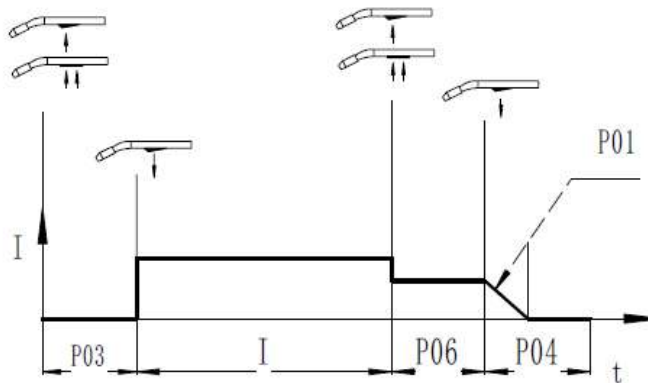

Fig. 4-3-6: 4-step mode

8. Inductance knob

To change the welding stability, penetration and spatter;

When inductance is decreased, there will be stiff, stable arc, smaller penetration and more spatter; When inductance is increased, there will be soft arc, bigger penetration, less spatter.

9. Crater filler current control knob

In 4-step mode, it is used to preset the crater filler current.

Important! The digital meter does not display the crater filler current value when presetting. When in crater filler status, it will display the real crater filler current value.

10. Crater filler voltage control knob

In 4-step mode, it is used to preset the crater filler voltage.

Important! The digital meter does not display the crater filler voltage value when presetting. When in crater filler status, it will display the real crater filler voltage value.

4-4 Interface

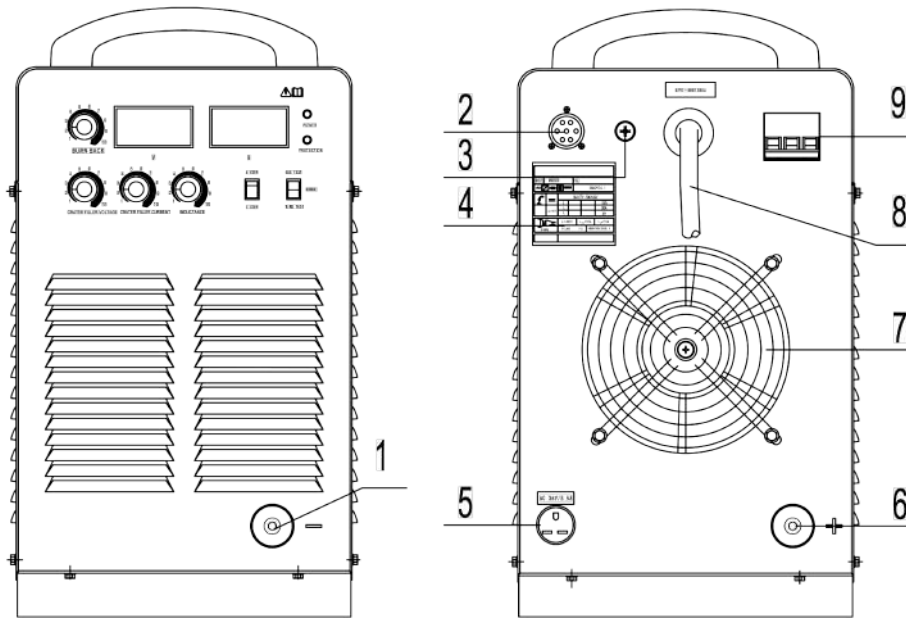

Fig. 4-4-1: Interface

1.Negative welding terminal (-)

Connect with work piece via ground cable.

2..Wire feeder control socket

For connecting with the control cable of wire feeder.

	PIN NO.	Description
	1	Connect with wire feeder motor
	2	+24V connect to solenoid valve
	3	Torch trigger
	4	Current/ Voltage preset signal
	5	Common GND for Torch trigger& Current/ Voltage preset
	6	Common GND for motor and solenoid valve
	7	Arc voltage feedback

Table. 4-4-1: Wire feeder control socket

3.Fuse

4.Nameplate

Please refer to the nameplate for the technical parameters of the welding machine.

5.Power supply socket for gas heater(36Vac).

6.Positive welding terminal (+)

Connect with the wire feeder .

7.Fan

8.Power cord

Three-phase four-wire system, yellow-green wire connection ground(PE: protecting earthing).

9.Circuit breaker

4-5 Installation



Warning! An electric shock can be fatal. If the machine is plugged into the mains electricity supply during installation, there is high risk of very serious injury and damage. Do not use the functions described here until you have read and completely understood “safety rules” in the beginning. Only carry out work on the machine when

- the mains switch is on turn-off position,
- the machine is unplugged from the mains

• Installation environment requirements

1. It should be placed indoors without direct sunlight, rainproof, low humidity and less dust. The ambient air temperature range is $-10^{\circ}\text{C}\sim+40^{\circ}\text{C}$.
2. The inclination to the ground should not exceed 10° .
3. There should be no wind in the welding station, if any, it should be covered.
4. The welding machine is more than 20cm away from the wall, and the distance between the welding machine is more than 10cm.
5. When using water-cooled welding torch, pay attention to anti-freezing.

• Power supply and cable requirement

Please note the size of fuse and circuit breaker in the table below are for reference only.

Model		500	630
Power supply		3 phase, 400Vac \pm 10%, 50Hz	
Min. power (KVA)	Power network	38	54
	Generator	50	70
Input protection (A)	Fuse	50	60
	Circuit breaker	63	100
Cable size (mm ²)	Power cord	≥ 6	≥ 10
	Welding cable	70	95
	Protective earthing(PE) wire	≥ 6	≥ 10

Table 4-5-1: Power supply

Note! Welding machine must be taken special design if it is powered by generator, please contact with manufacturer if you have such needs.

• connections of Power cord and distribution box



Warning! -Avoid hot-line work.

- Operating by professional electrician.
- Avoid connecting two power sources to one breaker.

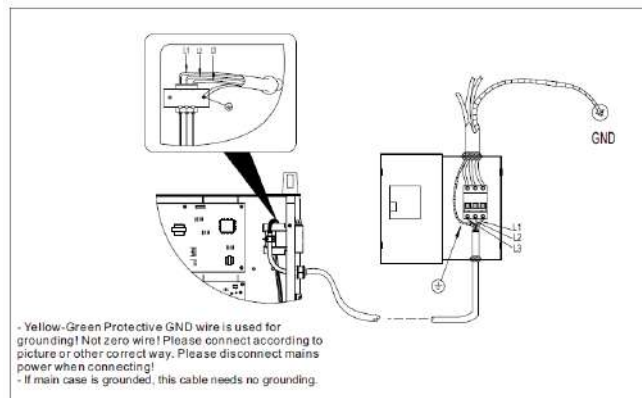
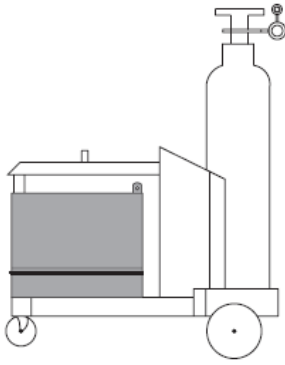

Fig. 4-5-1: Connections of power cord and distribution box

●Gas cylinder installation



1. Stand the gas cylinder on the trolley and secure it by fixing the cylinder strap around a point in the top third of the cylinder-but never around the neck of the cylinder.
2. Take the protective cap off the gas cylinder.
3. Gently turn the gas-cylinder value anticlockwise, and blow off any dust and dirt.
4. Screw the pressure regulator onto the gas cylinder and tighten it.
5. Connect the shielding-gas connector to the pressure regulator.

Fig. 4-5-2: Gas cylinder installation

4-6 Welding process



Warning! Operating the equipment incorrectly can cause serious injury and damage. This part is about operating. Do not use the functions until you have read and completely understood content of this manual.

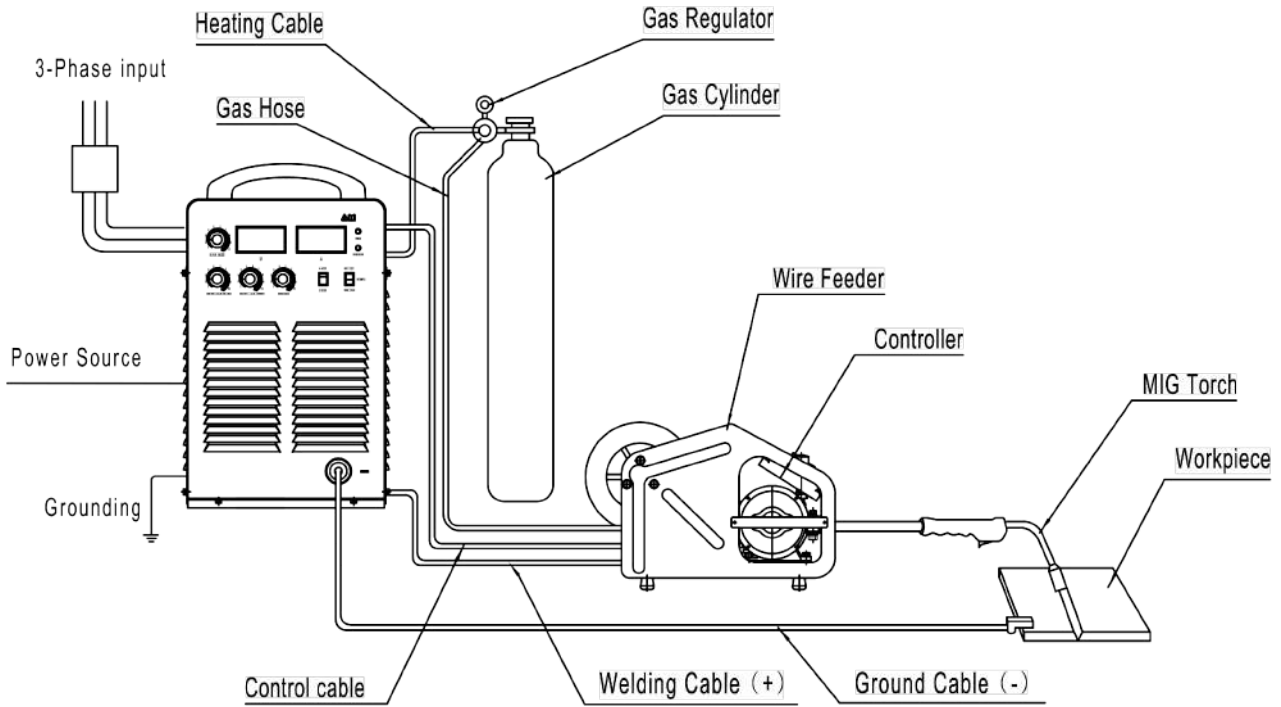

Fig. 4-6-1: Installation

4-7 Technical data



Note! Please use the machine under the allowed power supply voltage marked on the nameplate. The technical data with the basic input voltage are listed in the Table. 4-7-1.

Model	500	630
Voltage/Frequency	3 phase,400Vac±10%,50Hz	
Rated input capacity (KVA)	23	34
Rated input current (A)	33	51

Open circuit voltage(V)	82	95
Range of welding current (A)	60~500	60~630
Range of welding voltage (V)	15~50	
Rated duty cycle (%)	100	
Full-load efficiency (%)	≥87	
Wire size (mm)	Φ1.0~Φ1.6	
CO2 gas flow (L/min)	10~25	
Dimension (mm)	636×322×584	686×322×584
Weight (Kg)	50	60
Insulation class	H	

Table. 4-7-1: Technical data

4-8 Dimension

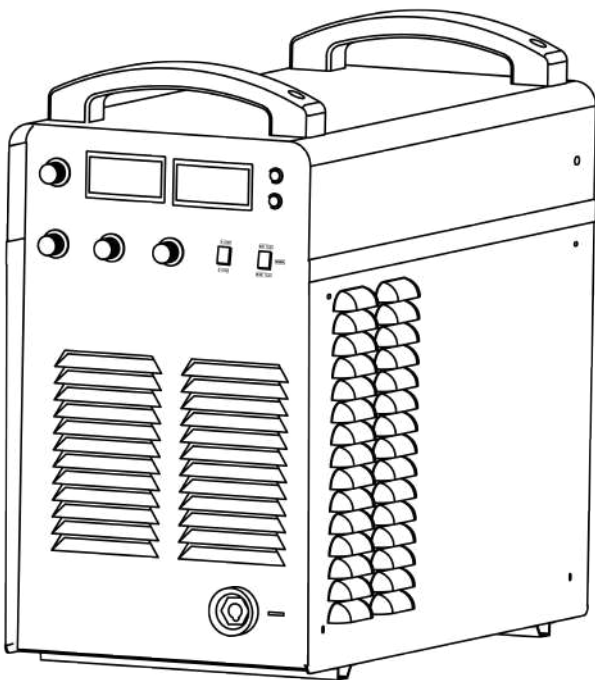

Fig. 4-8-1: Dimension

Model	500	630
Length(mm)	636	686
Width(mm)	322	322
Height(mm)	584	584

Table. 4-8-1: Dimension

4-9 Disassembly and reassembly

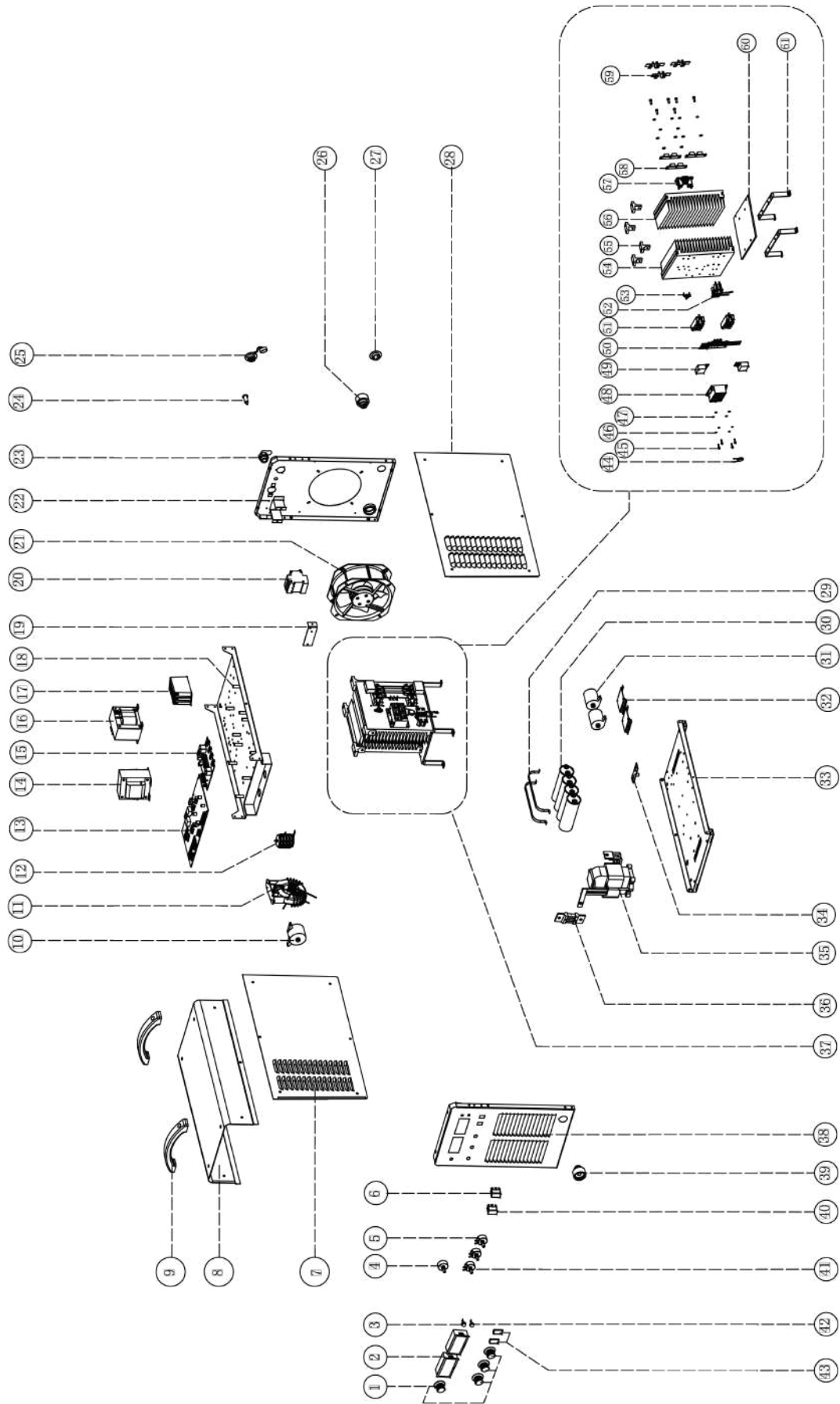

Fig. 4-9-1: Disassemble and reassembly

No.	Item	Stock No.500	Stock No.630	REMARKS
1	Potentiometer knob	720031-00138	720031-00138	
2	Digital display	755001-00023	755001-00023	
3	Light(red)	715002-00026	715002-00026	
4	Potentiometer	720031-00158	---	Burn back
5	Potentiometer	720031-00041	720031-00041	Inductance
6	Rocker switch	745002-00003	745002-00003	Gas test
7	Left plate	262017-00579	262017-00629	
8	Top plate	262029-00412	262029-00467	
9	Handle	766003-00138	766003-00138	
10	Resonance capacitor	722001-00074	722001-00075	
11	Main transformer	220629-00015	220629-00016	
12	Resonance inductor	220521-00004	220521-00004	
13	Main control board	210580-01299	210580-01285	
14	Power transformer I	763001-00048	763001-00048	
15	Drive board	210310-00096	210310-00096	
16	Power transformer II	763001-00049	763001-00049	
17	Filter	752004-00017	752004-00017	
18	Middle plate	263071-00146	263071-00352	
19	Main circuit breaker bracket	766003-02217	766003-02254	
20	Main circuit breaker	745011-00022	745011-00026	
21	Fan	746001-00087	746001-00035	
22	Rear plate	262011-00813	262011-00803	
23	Cable	769001-00028	769001-00093	
24	Fuse holder	740007-00004	740007-00004	
25	Control socket	74001-00047	74001-00047	
26	Quick socket	740002-00027	740002-00027	
27	European type socket	740004-00014	740004-00014	
28	Right plate	262023-00565	262023-00614	
29	Filter capacitor clamp	766003-00248	766003-00248	
30	Capacitor	722001-00062	722001-00062	
31	Filter capacitor	722001-00070	722001-00070	
32	Input capacitor holder	766002-01320	766002-01320	
33	Bottom plate	263065-00170	262065-00127	
34	Rack Capacitor Board	220293-00008	220293-00008	
35	Output reactor	763004-00228	763004-00116	
36	Shunt	720041-00010	720041-00010	
37	Radiator assembly	210340-01202	210340-01206	
38	Front panel	262005-01212	262005-01089	
39	Quick socket	740002-00027	740002-00027	
40	Rocker switch	745002-00002	745002-00002	2T/4T

41	Potentiometer	720031-00042	720031-00042	Crater filling
42	Light(yellow)	715002-00025	715002-00025	
43	Dust cover	745090-00002	745090-00002	
44	Varistor	720021-00017	720021-00017	
45	Screw	779001-00440	779001-00440	
46	Spring washer	779007-00017	779007-00023	
47	Flat washer	779007-00018	779007-00018	
48	Three phase rectifier modules	735005-00003	735005-00003	
49	Polypropylene capacitor	722001-00067	722001-00014	
50	IGBT protection board	220005-00135	220005-00008	
51	IGBT module	735007-00038	735007-00073	
52	Input filter inductor	220479-00002	220155-00004	
53	Temperature relay	745008-00045	745008-00044	
54	IGBT radiator	264005-00090	264005-00088	
55	Radiator support	766002-00090	766002-00090	
56	Output diode radiator	264011-00116	264011-00027	
57	Current exchange inductor	220281-00002	220281-00012	
58	Fast recovery diode module	735006-00029	735006-00029	
59	Diode protection board	220455-00002	220455-00002	
60	Radiator junction plate	775004-00027	775004-00009	
61	Radiator support frame	766002-00090	766002-00079	

Table4-9-1: Main components list

5- TROUBLE SHOOTING



Warning! An electric shock can be fatal. Before doing any work on the machine:

- Switch it off and unplug it from the mains
- Put up a clearly legible and easy-to-understand warning sign to stop anybody inadvertently switching it on again.
- Check to make sure the electrically charged components (e.g. Capacitors) have been discharged.
- Bolts in machine case also work for ground connection. Never use other bolt that can not work for ground connection.



Note! The flowing troubles and causes are uncertain. However, during the process of MIG and the normal using conditions, that might happen.

NO.	FAULT	CAUSE	REMEDY
01	Main circuit breaker is ON, but indicators are not lit up.	Input is default phase. Circuit breaker is damaged. Fuse (2A) is fusing.	Stop work Replace Replace
02	After power on, the circuit breaker on rear panel automatically tripped	Circuit breaker is damaged. IGBT module is damaged. Three phase rectifier bridge is damaged.	Replace Replace IGBT and drive board Replace or repair
03	During welding, the circuit breaker is tripped.	Overloading, the duty cycle has been exceed. Circuit breaker is damaged	Do not exceed the duty cycle. Replace
04	Can not adjust welding current value	Wire feeder control cable is broken. Check main control board is damaged or not. Main control board is damaged. Power sources inter connector is loose or break.	Reconnect Check and replace Fix or replace board Check and reconnect
05	Arc is not stable, spatter is higher	Incorrect welding parameters. Contact tip is worn out.	Check the settings Change the contact tip
06	CO2 gas regulator heater does not work	CO2 gas regulator is damaged. Heater cable is broken or short circuit. Thermistor of heater is damaged.	Replace Replace or reconnect Replace
07	When torch trigger is pressed, wire feeding is ok, while no shielding gas	main control board is damaged. The solenoid valve is damaged.	Fix or replace main control board Change the solenoid valve
08	When torch trigger is pressed, wire feeder does not work, and no open load voltage on displayer.	Torch trigger is damaged. Control cable for wire feeder is broken. Main control board in power source is damaged.	Replace or fix Reconnect Replace or fix
09	Fault indicator is lit up	Temperature relay is damaged. Wires connected to temperature relay maybe broken. Overloading, the duty cycle has been exceeded .	Replace Reconnect Do not exceed the duty cycle. Wait several minutes for cooling down and it will return to normal.

Table 5-1: Trouble shooting

6-CARE AND MAINTENANCE

- **Before open the machine**



Warning! An electric shock can be fatal. Before doing any work on the machine:

- Switch it off and unplug it from the mains
- Put up a clearly legible and easy-to-understand warning sign to stop anybody inadvertently switching it on again.
- Check to make sure the electrically charged components (e.g. capacitors) have been discharged.
- Bolts in machine case also work for ground connection. Never use other bolt that cannot work for ground connection.

Maintenance

Please follow the instructions as below to ensure normal lifespan of power source.

- Conduct safety check at regular intervals (see “Safety rules”)
- Dismantle machine side panels and clean machine inside with clean and low-pressure compressed air by professional technician, not less than twice per year. Clean the components at a certain distance only;
- If a lot of dust has accumulated, clean the cooling-air ducts.

- **Daily maintenance**

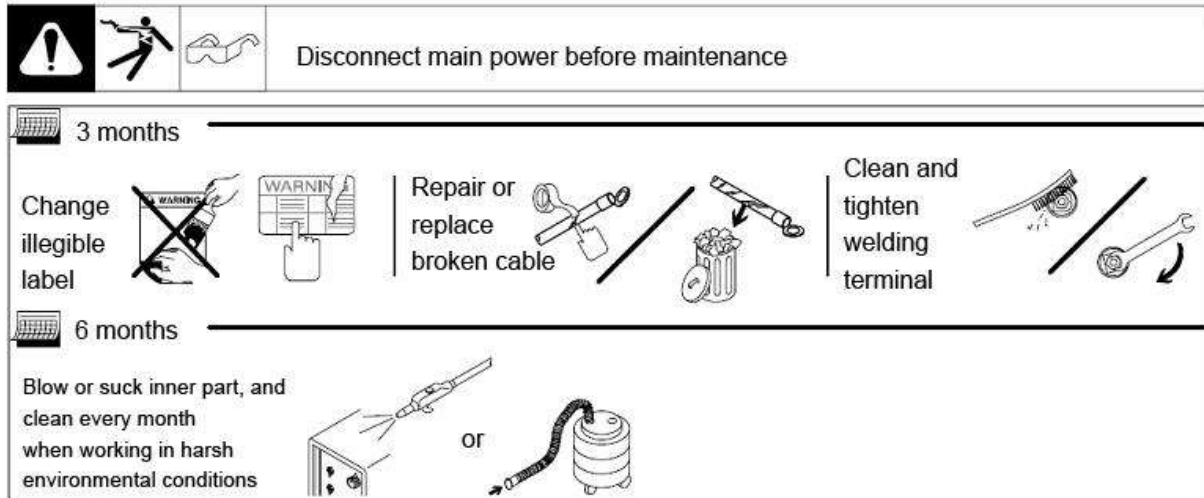

Fig. 6-1: Daily maintenance

Power MIG Series



GeKaMac[®]



Gedik Welding Inc.

Ankara Caddesi No: 306 Şeyhli 34906 Pendik - İstanbul / Turkey

P. +90 216 378 50 00 • **F.** +90 216 378 20 44

www.gedikwelding.com